

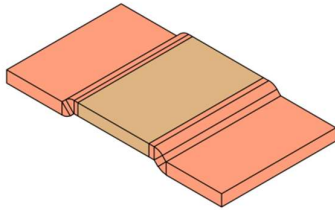

# SBB-5930 Series

Low Ohmic EB Welded SMD Precision Resistor



### Features

- 15Watts Permanent Power (0.2 mΩ)
- Constant Current up to 274 amps (0.2mΩ)
- High Conductivity Copper Connectors
- Excellent Long Term Stability
- High Application Temperature Range -55°C to +170°C
- Max. Solder Temperature up to 350°C / 30Sec
- Flame Resistant
- Solid Metal Construction
- RoHS and REACH Compliant
- AEC-Q200 Compliant

### Applications

- Current Sensing/ Feedback
- Automotive Applications
- Power Modules
- Frequency Convertors
- Inverters
- Low Inductance Applications



Technical Data		
Resistance Values	0.1,0.2,0.25,0.3,0.4, 0.5, 0.6,1, 2,3	(mΩ)
Tolerance	1, 5	(%)
TCR - Temperature Coefficient (Resistive Alloy)	<+20 (Copper Manganese Alloys) < -35(Aluchrom Alloy) <+20 (Nickel Chromium Alloy)	(ppm/K)
Applicable Temperature Range	-55 to +170	°C
Load Capacity	See Table 2	-
Inductance	<3	nH
Stability Deviation	< 0.5 after 2000 Hours, T <sub>t</sub> '= 110°C	%
	< 1.0 after 2000 Hours, T <sub>t</sub> '= 140°C	%

Table 1

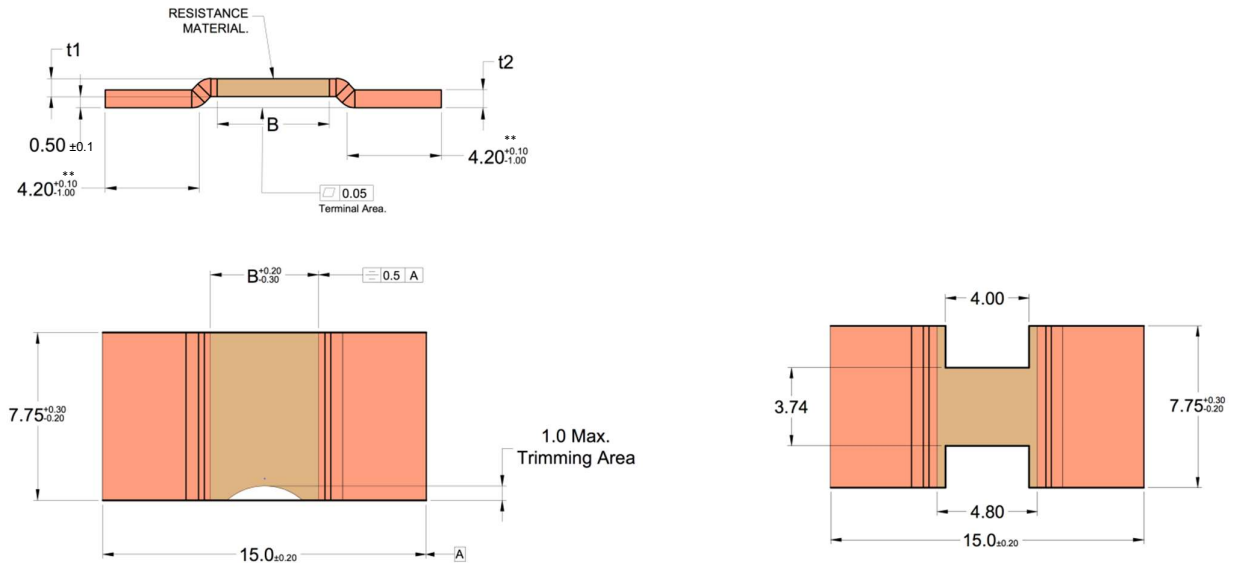

\*\* For SBB-CM4-R0001, 4.8 mm +0.1/-1.0 mm

For SBB(S)-AC-R002

All dimensions are in mm. See table 2 for thickness.



# SBB – 5930 Series

Low Ohmic EB Welded SMD Precision Resistor

## Resistance Change vs Temperature

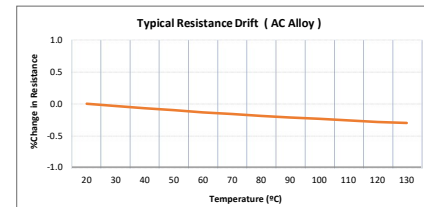
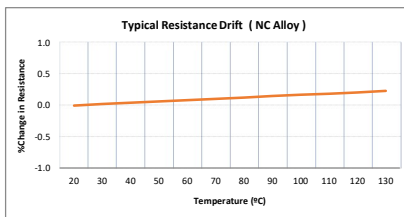
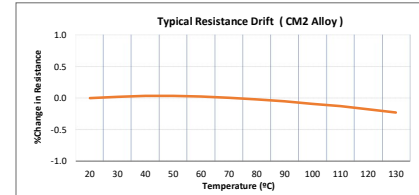
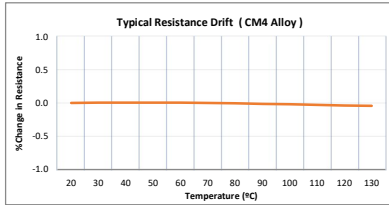

### Performance:

Type of Test	Reference STD	Test Specifications	Acceptance Criteria
High Temperature Exposure	MIL-STD-202 Method 108	1000Hrs. @ T=170°C.Unpowered.	ΔR +/-1%
Temperature Cycling	JESD22 Method JA-104	-55°C to 150°C, 1000Cycles, 30Mins at each extreme	ΔR +/-0.5%
Biased Humidity	MIL-STD-202 Method 103	85°C & 85RH with 10% operating power, 1000Hrs	ΔR +/-0.5%
Operational Life	MIL-STD-202 Method 108	125°C at rated power,1000Hrs	ΔR +/-1%
External Visual	MIL-STD-883 Method 2009	Visual inspection	Visual
Physical Dimension	JESD22 Method JB-100	Dimensional inspection as per SBCL Specifications	Shall confirm within tolerance limits
Resistance to Solvents	MIL-STD-202 Method 215	Clean with Aqueous chemical	Marking shall be legible
Mechanical Shock	MIL-STD-202 Method 213	100g for 6ms, Half sine	ΔR +/-0.2%
Vibration	MIL-STD-202 Method 204	5g for 20Mins, 12 cycles each of 3 orientations.10-2000Hz	ΔR +/-0.2%
Resistance to Soldering Heat	MIL-STD-202 Method 210	Solder Temp. 260°C, Time 10Secs	ΔR +/-0.5%
Solderability	J-STD-002	As per J-STD-002	>95% Coverage in 10x Magnification
Electrical Characterization	User Spec.	Resistance as defined	Shall confirm within tolerance limits
Short Time Over Load	--	5x Rated Power for 5Secs	ΔR +/-1%
Low Temperature Storage	--	-65°C for 24Hrs	ΔR +/-0.2%

### Power Derating Curve at 70°C (SBB-CM2-R0005)

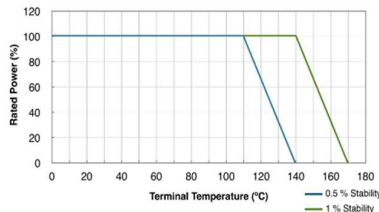



# SBB – 5930 Series

Low Ohmic EB Welded SMD Precision Resistor

Type	Resistance Value (mΩ)	Material	t1 +/- 0.10 (mm)	t2 +/- 0.10 (mm)	B (mm)	TCR (ppm)	P <sub>70°C</sub> (W) <sub>A@ Ambient</sub>	R <sub>thi</sub> (°C/W)	Wt. (nom.) gm	
SBB(S)-CM4-R0001	0.1	Copper Manganese Tin Alloy	1.42	1.42	3.7	< 400	15	2.0	1.47	
SBB-CM4-R0001	0.1	Copper Manganese Tin Alloy	1.42	1.42	3.7	< 300	15	2.0	1.47	
SBB-CM2-R0002	0.2	Copper Manganese Alloy	1.40	1.40	5.0	< 200	15	3.0	1.44	
SBB-CM2-R00025	0.25	Copper Manganese Alloy	1.12	1.12	5.0	< 200	10	3.0	1.15	
SBB-CM2-R0003	0.3	Copper Manganese Alloy	0.93	0.93	5.0	< 175	10	4.0	0.96	
SBB-CM2-R0004	0.4	Copper Manganese Alloy	0.72	0.72	5.0	< 175	9	8.0	0.74	
SBB-CM2-R0005	0.5	Copper Manganese Alloy	0.56	0.56	5.0	< 175	8	8.0	0.58	
SBB-AC-R0005	SBB-NC-R0005	Aluchrom Alloy	NiCr Alloy	1.62	1.42	4.4	< 100	10	8.0	1.53
SBB-CM2-R0006	0.6	Copper Manganese Alloy	0.47	0.47	5.0	< 175	8	8.0	0.48	
SBB-AC-R001	SBB-NC-R001	Aluchrom Alloy	NiCr Alloy	0.91	0.91	5.0	< 75	9	8.0	0.94
SBB-AC-R002	SBB-NC-R002	Aluchrom Alloy	NiCr Alloy	0.46	0.70	5.0	< 75	7	14.5	0.64
SBB(S)-AC-R002		Aluchrom Alloy	0.91	0.91	5.0	< 75	9	14.5	0.81	
SBB-AC-R003	3.0	Aluchrom Alloy	0.31	0.50	5.0	< 75	5	22.0	0.45	

Table 2

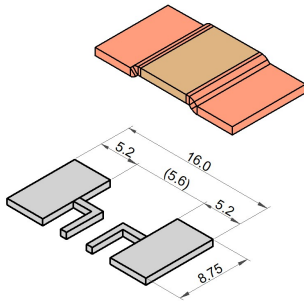

Standard Solder Pad Layout

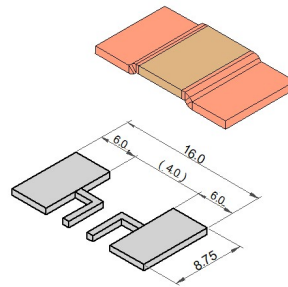

Optional :

Solder Pad Layout For Improved TCR (Applicable To SBB-CM4-R0001)

Reel Information	
Reference Standard	DIN EN 60286-3
Width of Reel	24 mm
Number of parts per Reel	2000 pcs



**Note:**

- 1) Recommended Solder Reflow Profile:

<http://www.shivalikbimetals.com/SRP-01.pdf>

- 2) Aluchrom is ferro -magnetic and is not recommended for AC applications. For AC applications use NiCr(NC) variant .



# SBB – 5930 Series

Low Ohmic EB Welded SMD Precision Resistor

## Example of ordering Code

